

AGX-550, AGX-552 & AGX-553

AUTOMATIC SPRAY GUNS OPERATION MANUAL

DEVILBISS

Important: Read and follow all instructions and SAFETY PRECAUTIONS before using this equipment. Retain for future reference.

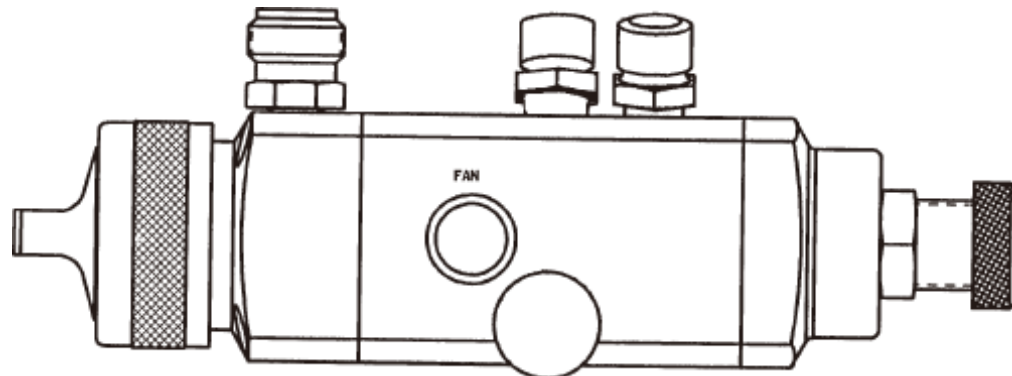

DESCRIPTION

The AGX spray gun is used on automatic and semi-automatic machines where mass production spraying of articles is necessary or hand spraying is not accurate enough. Models and application information follows.

NOTE:

This gun may be used with chlorinated solvents. Aluminum is not used in fluid passages. If using chlorinated solvents, make sure all other fluid handling components are also compatible.

Chart 1 MODELS

Model No. (Available Tip Sizes)	Typical Applications	Fluid Tip/Needle Construction
AGX-550 (AC, D, E, FF, FX, G)	Most conventional materials and most waterbornes and chlorinated solvents.	400 Gr. Stainless 303 Gr. Stainless
AGX-552 (D, EE, FF)	Abrasive materials (i.e. porcelain enamel, ceramic glazes, buffing compounds) and/or water mix materials. Includes abrasive fluid seal.	Carboloy, 400 Gr. Stainless
AGX-553 (E, FF, FX)	Waterbornes and more corrosive materials (below 7 pH)	303 Gr. Stainless w/U.H.M.W. poly. insert

SPECIFICATIONS

Max. Air Pressure	0.69MPa (100 psi)
Max. Fluid Pressure	0.69MPa (100 psi)
Cylinder Air Pressure	Min. 0.35MPa (*50 psi) Max. 0.69MPa (100 psi)
Weight	without mounting stud 737g with mounting stud 865g
Mounting Stud Diameter	3/4" (see Accessories for Optional 1/2" mounting)
Wetted Parts	AGX-550 300 & 400 Gr. Stainless, PTFE AGX-552 300 & 400 Gr. S.S., carboloy, PTFE AGX-553 300 Gr. S.S., PTFE, U.H.M.W. Poly.
Hose Connections	- Fluid Inlet 3/8" NPS(M) - Cylinder Air 1/4" NPS(M) - Atomization Air 1/4" NPS(M)

* For installations where 50 psi cylinder air is not available, the inner (red) piston spring can be removed which lowers the minimum cylinder air to approximately 37 psi. Refer to Operations, page 5, paragraph 2.

FLUID TIP ORIFICE SIZES

Letters on Tip	Inch	mm
AC	.110"	2.8
D	.086"	2.2
E	.070"	1.8
EE	.070"	1.8
FF	.055"	1.4
FX	.042"	1.1
G	.028"	0.7

FIGURE 1 DIMENSIONS

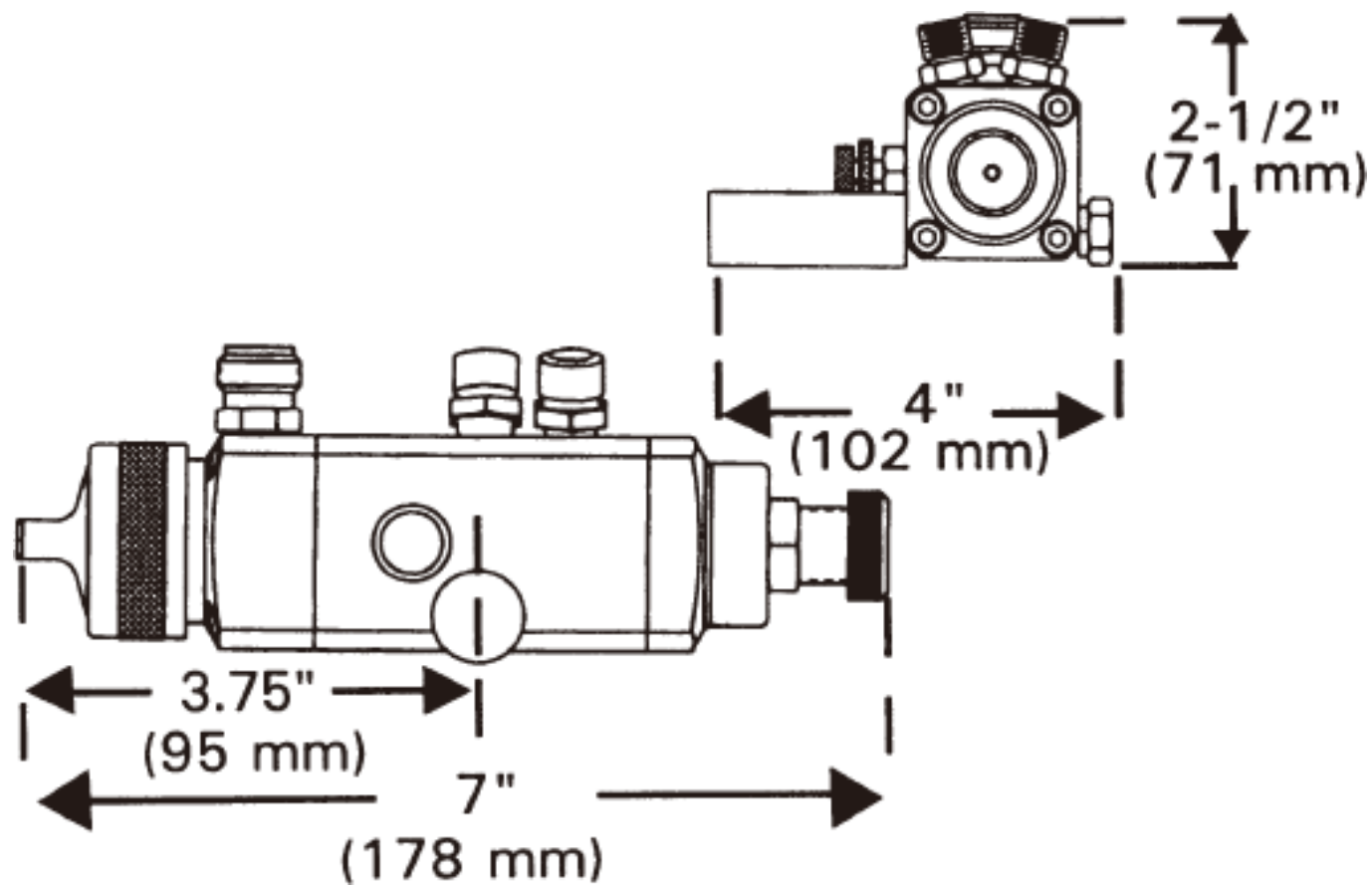

Tools Required:

- Adjustable wrench for hose connections
- 1/2" six point box wrench for Ref. (3)
- 9/16" open wrench for Ref. (9)
- 3/16" hex wrench for Ref. (6)
- Long neck pliers for Ref. (19)
- 1/8" hex key for Ref. (24)
- 1/2" and 9/16" socket wrench for Ref. (3) (9)

SAFETY PRECAUTIONS

This manual contains important information that ALL users should know and understand BEFORE using this equipment. This information relates to USER SAFETY and PREVENTING EQUIPMENT PROBLEMS.

To help you recognize this information, we use the following terms to draw your attention to certain equipment labels and portions of this manual. Pay special attention to any label or information that is highlighted by one of these terms:





PROP 65 WARNING

WARNING: This product contains chemicals known to the State of California to cause cancer and birth defects or other reproductive harm.

WARNING	Important information to alert you to a situation that might cause serious injury or loss of life if instructions are not followed.
CAUTION	Important information that tells how to prevent damage to equipment.
NOTE	Information that you should pay special attention to.

WARNING

The following hazards may occur during the normal use of this equipment. Please read the following chart.

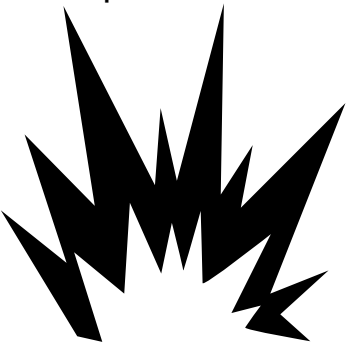
HAZARD	CAUSE	SAFEGUARDS
<p>Fire</p> 	<p>Solvents and coatings can be highly flammable or combustible, especially when sprayed.</p>	<ol style="list-style-type: none"> 1. Adequate exhaust must be provided to keep the air free of accumulations of flammable vapors. 2. Smoking must never be allowed in the spray area. 3. Fire extinguishing equipment must be present in the spray area. 4. Static discharges must be prevented. Ground (earth) all conductive objects in the spray area, such as a cleaning solvent bucket, fire extinguisher, etc. 5. When using solvents for cleaning: <ul style="list-style-type: none"> · Those used for equipment flushing must have a flash point equal to or greater than that of the coating. · Those used for general cleaning must have flash points above 100°F (37.8°C).
<p>Inhaling Toxic Substances</p> 	<p>Certain materials may be harmful if inhaled or if there is contact with the skin.</p>	<ol style="list-style-type: none"> 1. Follow the requirements of the Material Safety Data Sheet supplied by coating material manufacturer. 2. Adequate exhaust must be provided to keep the air free of accumulations of toxic materials. 3. Use a mask or respirator whenever there is a chance of inhaling sprayed materials. The mask must be compatible with the material being sprayed and its concentration. Equipment must be as prescribed by an industrial hygienist or safety expert, and be NIOSH approved.
<p>Explosion Hazard – Incompatible Materials</p> 	<p>Halogenated hydrocarbon Solvents- for example: methylene chloride and 1,1,1,-Trichloroethane are not chemically compatible with the aluminum that might be used in many system components. The chemical reaction caused by these solvents reacting with aluminum can become violent and lead to an equipment explosion.</p>	<p>The AGXV spray gun can be used with these solvents. However, aluminum is widely used in other spray application equipment – such as material pumps, cups, regulators, valves, etc. Check all other equipment items before use of these solvents. Read the label or data sheet for the material you intend to spray. If in doubt as to where or not a coating or cleaning material is compatible, contact your material supplier.</p>

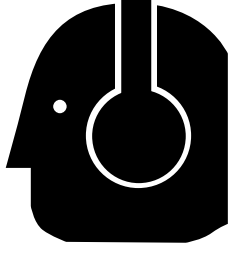
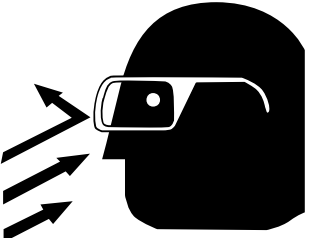
HAZARD	CAUSE	SAFEGUARDS
General Safety	Improper operation or maintenance may create a hazard.	Operators should be given adequate training in the safe use and maintenance of the equipment (in accordance with the requirements of NFPA-33, Chapter 15 in U.S.). Users must comply with all local and national codes of practice and insurance company requirements governing ventilation, fire precautions, operation, maintenance and housekeeping (in the U.S., these are OSHA Sections 1910.94 and 1910.107 and NFPA-33).
Noise Levels 	The continuous A-weighted sound pressure level of this spray gun may exceed 85dB(A) depending on the air cap/nozzle set-up being used. Sound levels are measured using an impulse sound level meter and analyzer, when the gun is being used in a normal spraying application. Details of actual noise levels produced by the various air cap/nozzle set-ups are available on request.	Wear earplugs when using the spray gun.
Spraying solvent 	Pressured air/fluid passage may be broken when cleaning or flashing with solvent. The solvent may be harmful if contacted with eyes.	Always wear eye protection when spraying or cleaning the equipment.

Misuse:

- All spray guns project particles at high velocity and must never be aimed t any part of body.
- Never exceed the recommended safe working pressure for any of the equipment used.
- The fitting of non-recommended or non-original accessories or spare parts may create hazardous conditions.
- Before dismantling the equipment for cleaning or maintenance, all pressures, air and material, must be isolated and released.

Disposal of non-metallic materials must be carried out in an approved manner. Burning may generate toxic fumes. The removal of waste solvents and coating materials should be carried out by an authorized local waste disposal service.

INSTALLATION

Mount the gun with the stud (13) or on a 5/16" dia. rod tightening adequately with the 1/4-28 X 1/4" set screws (Ref. No. 24). See "ACCESSORIES" for mounting clamps.

Figure 2. TYPICAL INSTALLATION

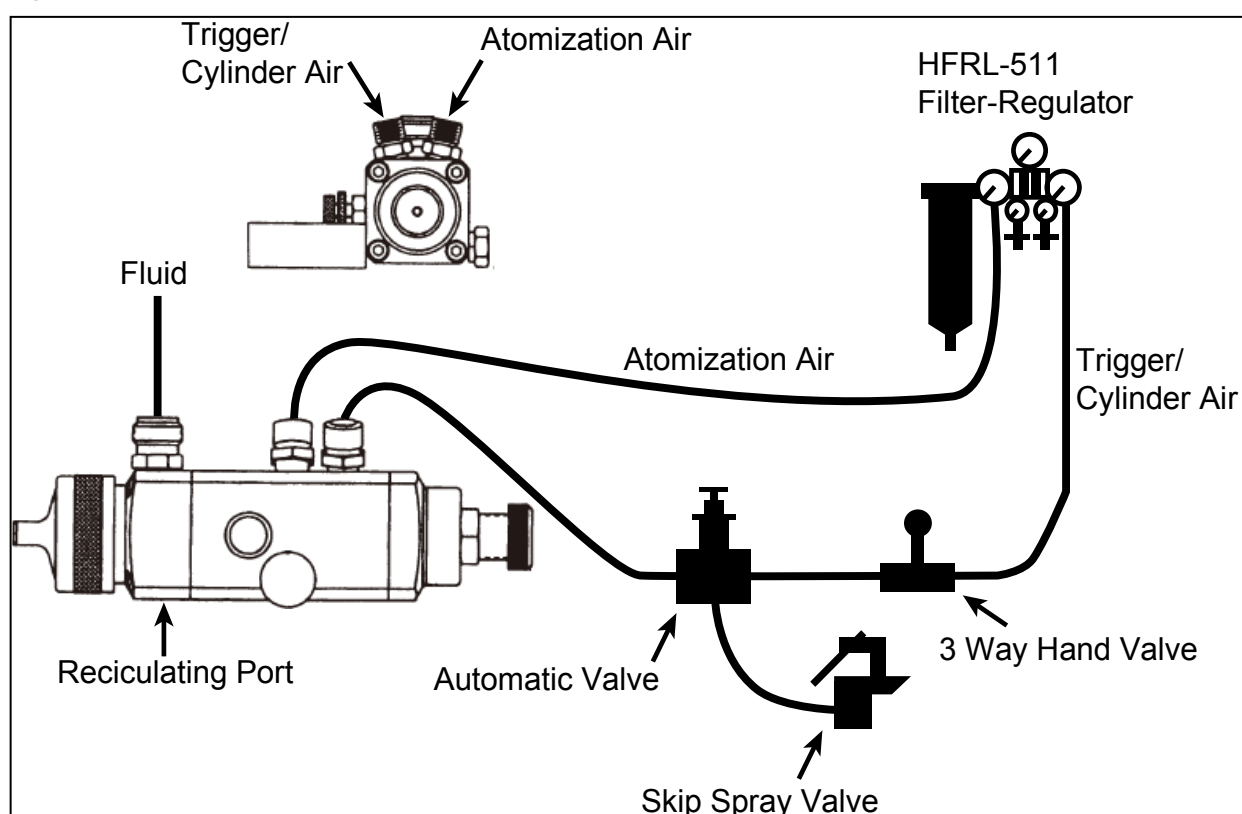

Attach trigger/cylinder air hose and atomization air hose to connections as indicated by markings on gun body. The air supply should be filtered and regulated. Attach material hose to fluid inlet on the body. Fluid can be recirculated by installing a fluid fitting (AGX-415) (order separately) at recirculating port. See Caution below.

CAUTION

The fluid inlet and recirculating ports have a tapered seating surface intended for use with the AGX-415 fitting. Do not substitute other fittings as fluid leakage will occur.

Note

If replacing the atomization air connection (15) with an elbow type connection, be aware of a possible air flow (CFM) limitation. A 1/4" I.D. 90° elbow will only pass 20 CFM @ 0.28MPa. Some air caps require more than 20 CFM. Spray performance could be affected.

OPERATION

1. Mix, prepare and strain material to be sprayed according to paint manufacturer's instructions. Use a lint free mesh to strain material.
2. Turn on cylinder air at source of supply. Supply air should be a minimum of 0.35MPa (3.5 bar). For consistent operation the pressure should be regulated. If 0.35MPa cylinder air pressure is not available, the red inner spring (31) can be removed. This allows a minimum cylinder pressure of approximately 0.26MPa.

Note

If red inner spring (31) is removed, atomization pressure should not exceed 0.48MPa (will result in gun not shutting off).

3. Turn needle adjustment knob (25) counterclockwise several turns. With cylinder air on, turn adjustment knob (25) clockwise until it contacts piston (19) (for maximum fluid flow). Back knob out 1/2 turn.

Note

Due to close part tolerances, actuate gun on and off 7 or 8 times to "break-in" the packings. Do this with material supply off.

4. Adjust atomization air pressure to 0.35MPa (3.5 bar). Always attempt to keep pressure as low as possible to minimize overspray. The fluid pressure should be between 0.07MPa to 0.1MPa (0.7 to 1.0 bar).
5. Open hand valve and/or trip automatic valve if installed in system and observe spray pattern. Adjust air and fluid pressures until desired pattern is obtained. Control fluid pressure at source of supply. If desired regulation is not practical at this point, restrict flow by turning adjustment knob (25) clockwise.
6. The width of spray pattern is controlled by adjusting valve (23) marked "FAN". With "FAN" valve screwed fully clockwise, spreader air will be closed off causing a round pattern. By gradually opening this valve, pattern changes to a fan spray. The width is determined by amount valve is opened. Atomization air is adjusted by regulating supply air to gun.

CHART 2 FLUID TIPS AND NEEDLES

AGX-550 GUN – 400 Gr. Stainless Tip / 303 Gr. Stainless Needle				
Tip Size	in.	mm	Fluid Tip Number	Needle Number
AC	.110"	2.8	AV-2115-AC	AGX-402-AC
D	.086"	2.2	AV-2115-D	AGX-402-D
E	.070"	1.8	AV-2115-E	AGX-402-E
FF	.055"	1.4	AV-2115-FF	AGX-402-FF
FX	.042"	1.1	AV-2115-FX	AGX-402-FX
G	.028"	0.7	AV-2115-G	AGX-402-G
AGX-553 GUN – 303 Gr. Stainless & UHMW Poly.				
Tip Size	in.	mm	Fluid Tip Number	Needle Number
E	.070"	1.8	AV-4915-E	AGX-402-E
FF	.055"	1.4	AV-4915-FF	AGX-402-FF
FX	.042"	1.1	AV-4915-FX	AGX-402-FX
AGX-552 GUN – Carbolloy - Tip / Needle Set				
Tip Size	in.	mm	If this Number on Tip order ➡	Tip / Needle Set
D	.086"	2.2	AV-1415-D	AGX-4410-D
EE	.070"	1.8	AV-1415-EE	AGX-4410-EE
FF	.055"	1.4	AV-1415-FF	AGX-4410-FF

Adjustments to fan may be controlled remotely by using the optional KK-4955 fan control adapter to replace the AGG-403 control valve (23).

Figure 2A. AIR CIRCUIT EXAMPLE WITH OPTIONAL KK-4955 REMOTE FAN CONTROL

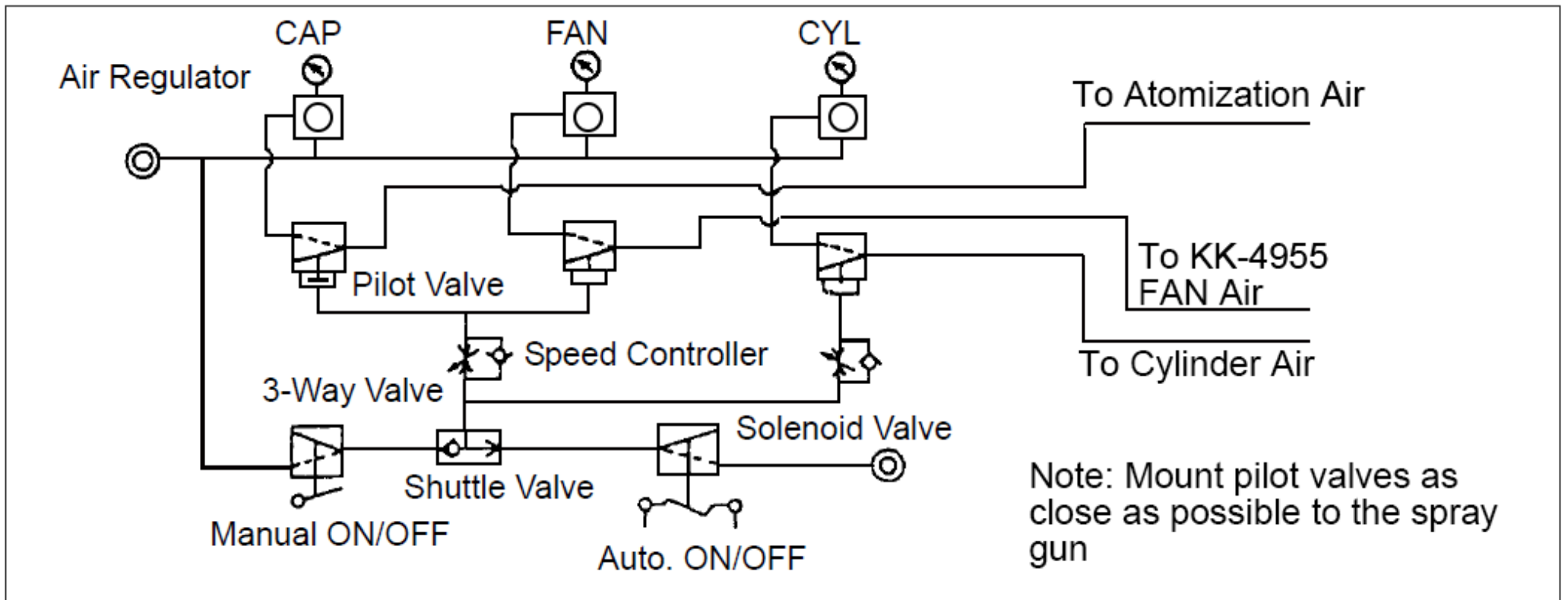

7. Close automatic valves and begin operation.

CHART 3 AIR CAPS

If this No. on Cap, Order→	Ref. No. (2) Air Cap Less Retaining Ring	Ref. No. (1 & 2) Air Cap with Retaining Ring
24	AV-40-24	
30		MB-4039-30
58		AV-439-58
62		MB-4039-62HD
64		MB-4039-64HD
704	AV-1239-704	
765	AV-1239-765	
777	31767-777	
797	AV-1239-797	

PREVENTIVE MAINTENANCE

WARNING

Risk of Injury. Equipment and fluid may be under pressure.

Pressure in the system must be relieved before beginning the cleaning procedure and before replacing any parts. Follow the procedures in the service literature provided with the system.

CLEANING

1. Relieve air pressure from pressure tank. Carefully follow instructions in the service bulletin sent with tank.
2. Replace material in container with a suitable solvent.
3. Re-pressurize system.
4. Trigger gun and repeat procedure until gun and hose are thoroughly clean. A SolventSaver™ type hose and gun cleaner which supplies a mixture of air and solvent can be used to most effectively clean gun and hose internal passages. See "Accessories" for SolventSaver™. Wipe exterior of gun with a solvent dampened cloth.
5. If a recirculating system is used, it may be necessary to fit a shut off valve in return line to ensure fluid tip and forward portion of sprayhead passage are properly cleaned when flushed with solvent.
6. Refer to page 12 for optional gun and hose cleaners.

CAUTION

Do not totally submerge gun in solvent. It is possible to wash solids into air operating sections of gun which could seriously damage piston o-ring seals.

CAUTION

The air cap can be immersed in solvent for cleaning. If orifices are clogged, use a broom straw or toothpick to remove obstruction. Never use a steel wire or hard instrument. This will damage air cap and result in a distorted spray pattern.

REPLACEMENT

Fluid needle (28) and Tip (3)

CAUTION

To prevent possible damage to the fluid tip (3) or needle (28), always remove the adjustment knob (25) before loosening or tightening the fluid tip.

CAUTION

To prevent possible damage to the spray gun, do NOT loosen or tighten the fluid tip (3) if the fluid inlet (9) is removed. The stainless steel insert may turn within the gun body.

1. Relieve all air and fluid pressure in system.
2. Remove retaining ring (1) and air cap (2).
3. Remove fluid tip (3).
4. It is recommended that both the fluid tip (3) and needle (28) be replaced at the same time. The needle packings (11) should also be replaced when replacing the needle.
5. Remove baffle (5). It should be replaced if it is damaged or filled with foreign material.
6. Remove adjusting knob (25).
7. Remove needle (28) with pliers.
8. Reassemble in reverse order.

Fluid Needle (28) and Fluid Needle Packings (11)

1. With sprayhead (8) and adjusting knob (25) removed, the fluid needle (28) and packings (11) can be easily removed and replaced. See step 4 above.
2. Slide onto the new needle (28), in this order, 1 packing (11), spring (12) and 1 packing (11). Be sure to orient packings (11) as shown. For Model AGX-552, slide brass collar piece and seal (32) over needle.
3. Insert new needle into gun and slide packings and spring over needle.
4. Assemble sprayhead (8) with retaining screws (7).
5. Tighten screws (7) with a 3/16 hexagon key 30-40 in. lbs. until the body is flush with sprayhead assembly.

Piston (19) , O-Rings (17 & 18) and Seal (20)

1. Remove piston housing (29) by removing rear retaining screws (7).
2. Remove fluid needle (28).
3. Remove springs (30, 31 & 27) and piston (19). Care must be taken when removing piston (19). Use a locking long nose pliers to extract piston by clamping on inner ring on back of piston.
4. Remove air packing (20), o-rings (17 & 18).
5. Wipe clean bore of cylinder. Replace piston o-rings (17 & 18) and lightly lubricate with clean petroleum jelly. See Lubrication section which follows.
6. To replace air packing (20) (inside of piston), slide packing (20) over the needle (28) with lead-in chamfer towards the fluid tip end of needle. Insert needle into the piston (19). Hold piston in your hand so that tip end of needle is protruding downward (protect needle from damage). Lightly tap blunt end of needle to drive packing down into piston. The needle will stop inside piston at a shoulder.
7. Fit complete assembly into gun.
8. Lubricate outside of springs (27) and (30) (see Lubrication section), then re-install springs and piston housing (29) and tighten down and torque mounting screws (7) 30-40 in. lbs.
9. Lubricate adjustment knob threads (25) after cleaning with SSL-10 Gun Lube. Loosen locking nut (26) before screwing the adjustment knob in.

Plug (6) or Fluid Insert(9)

WARNING

Halogenated Hydrocarbon solvents can chemically react with aluminum. A risk of explosion or severe corrosion will occur. The following assembly step must be carefully performed.

If replacing AGX-415 inlet fitting, or if it should loosen, follow assembly procedures below.

1. If installing a used fitting, clean paint and thread sealant from fitting threads and gun body using a brass or bronze wire brush/bottle brush.
2. Screw jam nut all the way onto fitting. Then apply Loctite medium strength #242 (blue) to first few threads of the fitting.
3. Install AGX-415 fitting into spray gun and tighten to a maximum of 12 ft. lbs. torque. (Do not overtighten, damage may occur.)
4. Tighten jam nut to 16 ft. lbs. torque using a thin 9/16" open end wrench.
5. Use two adjustable wrenches when removing a hose connection from AGX-415 to prevent inlet fitting from loosening.

Figure 5. Gun Exploded View

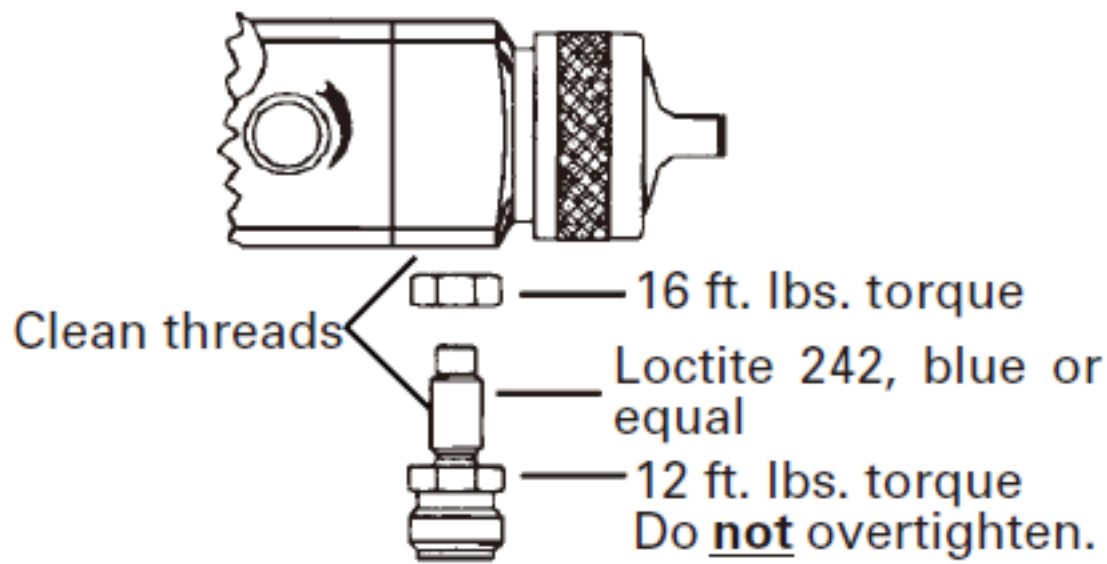

HVLP Conversion

This gun can be converted to HVLP by ordering parts listed below.

Sprayhead Assembly AGXV-400

Baffle AGHV-403

Air Cap (Order One) JGHV-101-33A

JGHV-101-46MP

(For Max. Performer, also order AV-2120-FF fluid tip and AGX-402-FF needle OR AV-2120-FX fluid tip and AGX-402-FX needle.)

JGHV-101-83MP

(For Max. Performer, also order AV-2120-E fluid tip and AGX-402-E needle OR AV-2120-D fluid tip and AGX-402-D needle.)

LUBRICATION

The piston o-rings (17 and 18) must be lubricated when piston (19) is removed. Lightly lubricate with clean petroleum jelly. Petroleum jelly is effective as a lubricant up to approximately 110°F. Above 110°F, petroleum jelly will become "liquid" and will not lubricate the o-rings adequately. If ambient temperature adjacent to spray gun exceeds 110°F, use Parker O-Lube. This allows the spray gun to be used in temperatures up to 150°F continuous without lubrication degradation.

Lubricate outside of larger piston spring (30) and needle spring (27) with a light coating of non-silicone grease. Apply a thin film of petroleum jelly to fluid needle (28) as shown on page 6, note 1.

Note

Due to close part tolerances, after repairing the gun, actuate gun on and off 7 or 8 times to "break-in" the packings. Do this with material supply off.

Figure 4 GUN ASSEMBLY

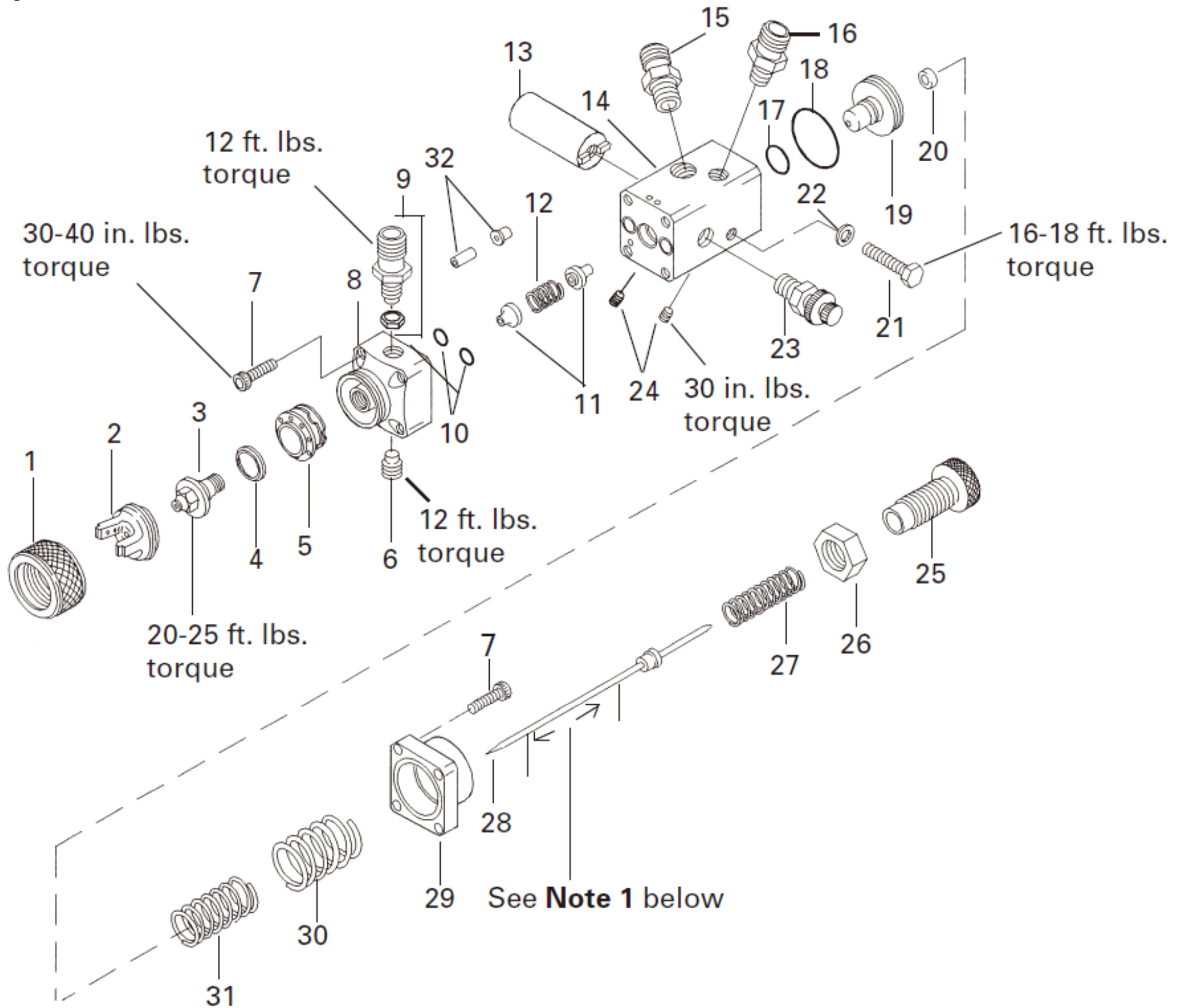

Item No.	Replacement Part No.	Description	Ind. Parts Req' d.
1	MBC-368	Retaining Ring	1
2*	See Chart 3	Air Cap	1
3*☆	See Chart 2	Fluid Tip	1
4*▲	AV-1-K5	Gasket	1
5	MBC-1225	Baffle	1
6	AGX-6-K3	Fluid Outlet Plug (Kit of 3)	1
7	SSF-3156-K4	Mounting Screw (Kit of 4) (torque 30-40 in. lbs.)	8
8	AGX-403	Sprayhead Assembly	1
9	AGX-415	Inlet Fitting and Jam Nut	1
10*▲	---	O-Ring	2
11*▲	AGX-7-K2	Needle Packing	2
12*▲	---	Seal Spring	1
13	KK-4995	Gun Mounting Stud Kit (Includes items 21 & 22)	1
14	AGX-11	Body	1
15	H-2008	Nipple 1/4 NPS(M) x 1/4 NPT(M)	1
16	H-1766	Nipple 1/4 NPS(M) x 1/8 NPT(M)	1
17*▲	---	O-Ring	1
18*▲	---	O-Ring	1
19	AGX-9	Piston	1

Item No.	Replacement Part No.	Description	Ind. Parts Req' d.
20* [▲]	---	Air Packing	1
21	---	Hex Head Cap Screw, 5/16-18 x 2-1/4	1
22	---	5/16 Lockwasher	1
23	AGG-403	Air Valve Assembly - Horn	1
24	---	1/4-28 x 1/4" Large Knurled cup point set screw	2
25	AGX-2-1-K3	Adjustment Knob (Kit of 3)	1
26	34215-122	Locknut	1
27* [■]	---	Needle Spring	1
28* [☆]	See Chart 2	Fluid Needle Assembly	1
29	AGX-10	Piston Housing	1
30* [■]	---	Outer Piston Spring	1
31* [■]	---	Inner Piston Spring (Red)	1
32*	KK-5017	Abrasive Fluid Seal Kit (Model AGX-552, includes 3 seals and 1 collar)	1

* Recommended spare parts.

[▲] Parts included in KK-4992-1 Gun Repair Kit.

[☆] Order tip and needle set, see Chart 2.

[■] Springs included in KK-4993 Spring Kit.

Detail Ref. No. 32

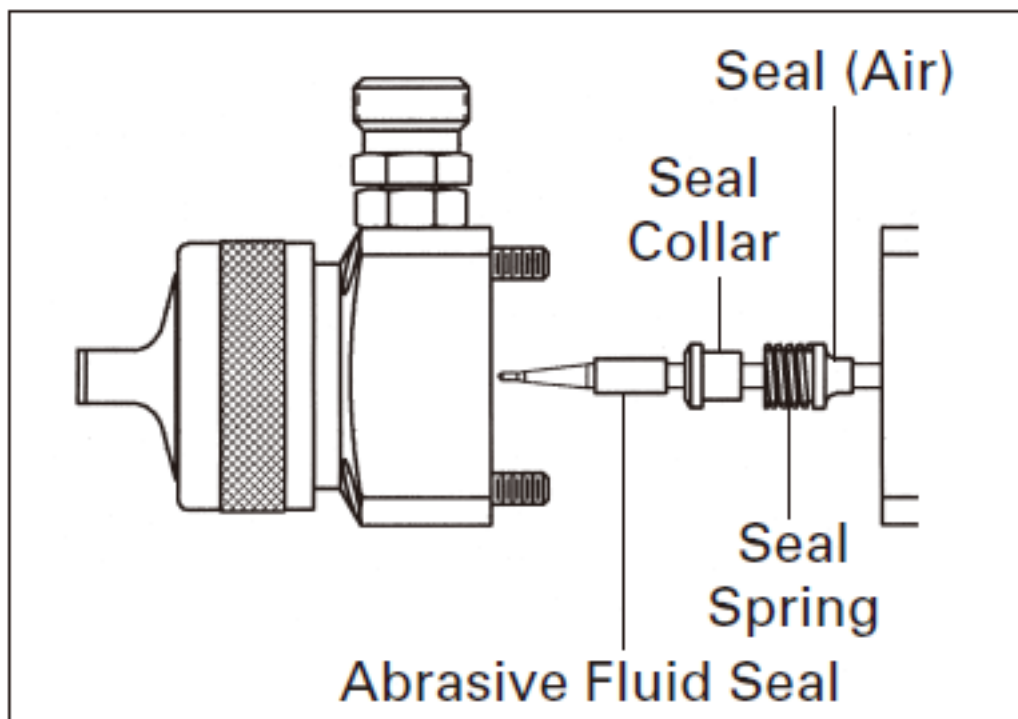

Note

Apply a thin film of petroleum jelly to the fluid needle as shown



SERVICE CHECK

Normal spray pattern









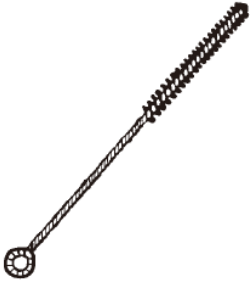

The proper combination of fluid pressure, fan and atomization air pressure, and fluid tip size should result in a pattern of this shape.

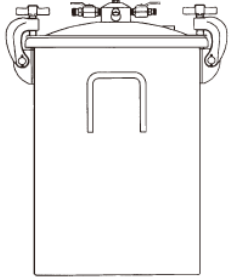
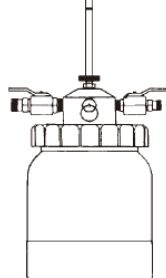
Proper gun adjustment will result in normal spray patterns, from round with the fan control valve (23) closed, to long and narrow with the valve open. Pattern width depends upon how much the valve is opened, the type of air cap used and fluid flow rate.

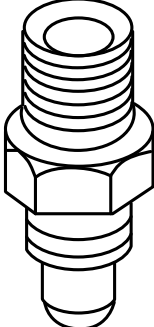
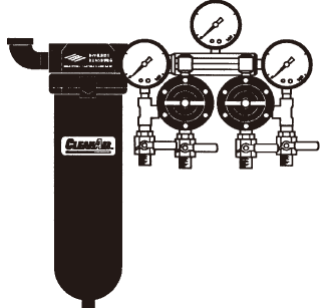
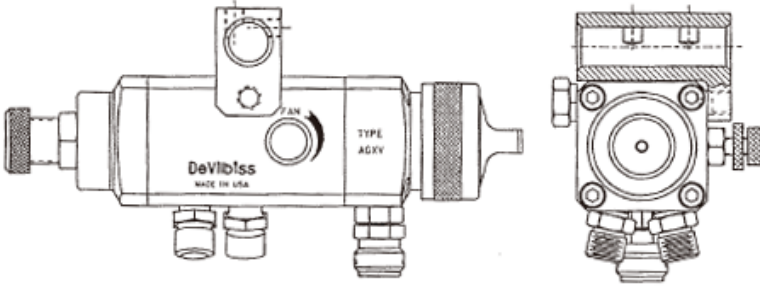
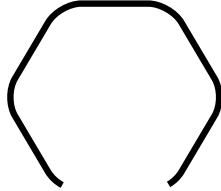
problem	Cause	Correction
Will not spray.	No pressure to gun. Piston stops moving. New air packing (20)	Check air and material lines. Check tightness of socket screws (7). Remove fluid needle (28) and lubricate with petroleum jelly and reassemble.
Improper spray pattern. 	A. Gun not adjusted properly. A, B. Material build up on the air cap or fluid tip. Note To determine where the material build up is, rotate the air cap 180° and test spray. If the pattern stays in the same position, the condition is caused by material build up on the fluid tip. If the pattern changes with air cap movement, the buildup is in the air cap. C, D. Wrong material or material too thick. Insufficient material or atomizing air pressure too high.	A. Re-adjust. See "Operation Section". A, B. Clean the air cap or fluid tip. See "Preventive Maintenance". C, D Adjust material pressure or thin material. Increase material or reduce atomizing air pressure.
Jerky or fluttering spray 	1. Insufficient material in the tank or an obstruction in the line. 2. Gun material passage plugged. 3. Worn packings (11). 4. Loose or damaged Fluid Tip.	1. Fill tank or clear obstruction. 2. Clean. 3. Replace. 4. Tighten or replace.
Fluid leaking from needle Needle packings (11).	1. Needle packings (11) worn. 2. Damaged cylinder of Gun Body (6).	1. Replace. 2. Replace.
Dripping from Fluid Tip.	1. Worn or damaged fluid tip (3) or needle (28). 2. Piston springs (30) and/or (31) damaged or deformed. 3. Check to verify only one air packing (20) is installed in piston.	1. Replace. 2. Replace. 3. Remove extra.
Air Leakage from Control Valve (23)	Worn seals.	Replace valve. (23).

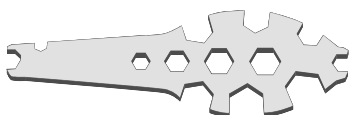
ACCESSORIES

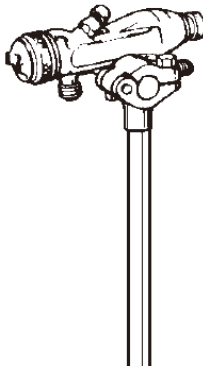
<p>42884-214-K5 3/8" 42884-215-K10 5/8" Cleaning Brushes</p>	<p>AGA-415 Universal Clamp</p>	<p>183GZ-5200 Hose/Gun Cleaner SolventSaver™</p>	<p>HD-503 (2 qt.) Hose/Gun Cleaner SolventSaver™</p>	<p>SSL-10 Spray Gun Lube 2 oz. bottle</p>
 <p>These brushes are helpful in cleaning threads and recesses of gun body.</p>	 <p>Attaches to the gun stud (13), clamps onto (3/4") diameter rod.</p>	 <p>2 gallon galvanized tank used to clean the inside of hose and material passages of the gun.</p>	 <p>Used to clean the inside of hose and material passages of the gun.</p>	 <p>Use on air cap and retaining ring. Compatible with all paint materials, contains no silicone or petroleum distillates to contaminate paint. MSDS available upon request.</p>
<p>KK-4955 Fan Control Adapter Kit</p>	<p>HFRL-511 Filter-Regulator</p>	<p>KK-5046 Mounting Block Kit</p>		<p>JGA-156-K10 Spring Clips</p>
 <p>Used for adjusting pattern size from a remote air source.</p>	 <p>Use in the line between the source of air supply and the gun for the purpose of extracting dirt and entrained water and oil. Will also enable users to regulate and control atomization air pressure to the gun.</p>	 <p>Allows gun to be mounted on a 1/2" rod.</p>		 <p>Joins any single piece DeVilbiss air cap with latest version MBC- 368 or MSA-1 retaining ring. Helps prevent parts loss and provides easier assembly.</p>
<p>Millennium 3000 Twin Cartridge Paint Spray Respirator</p>	<p>WR-103 Wrench</p>	<p>29-3100 Scrubs® Hand Cleaner Towels</p>	<p>AGA-414 Extension Road Assembly</p>	
 <p>NIOSH-Certified, for respiratory protection in atmospheres not immediately dangerous to life.</p>	 <p>Contains all necessary tip, hose and nut sizes used on or with gun.</p>	 <p>Scrubs® are a premoistened hand cleaner towel for painters. No water is needed.</p>	 <p>Rod Length: 16 inches Rod Diameter: 3/4 inch Clamp Diameter: 3/4 inch</p>	

Pressure Feed Tanks:

183G Galvanized and 183S Stainless Steel pressure feed tanks are intended for use as a pressure container to supply material at a constant preset pressure.

KK-5017 Fluid Seal Kit

– For use with abrasive materials. Includes 1 brass seal collar and 3 polyethylene fluid seals.

DEVILBISS DIVISION

CFT Ransburg Japan KK

15-5, Fukuura 1-chome, Kanazawa-ku, Yokohama, Kanagawa Japan 〒236-0004
TEL : +81-45-785-6434 / FAX : +81-45-785-6517

website <http://www.carlisleleft.co.jp/>

©DEVILBISS is a registered trademark of Carlisle Fluid Technologies
©Jupiter is a registered trademark of CFT Ransburg Japan KK.



©2017 Carlisle Fluid Technologies.

2017-08- AGX